

Prepainted Long-length  
Steel Roofing Sheet

# Rumako

The Beauty of Tile with  
the Strength of Steel

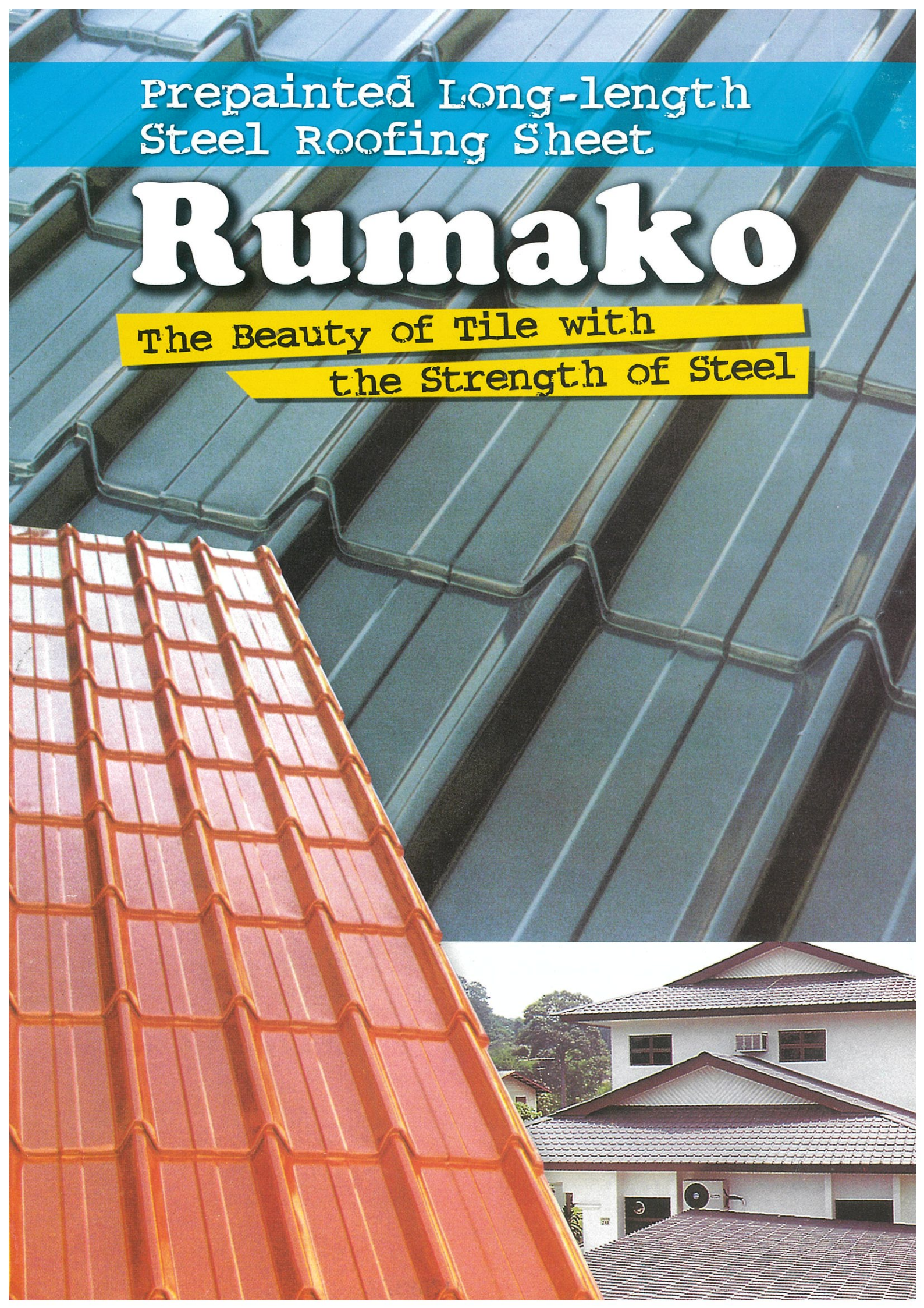



# Rumako

## STANDARD MATERIAL SPECIFICATION

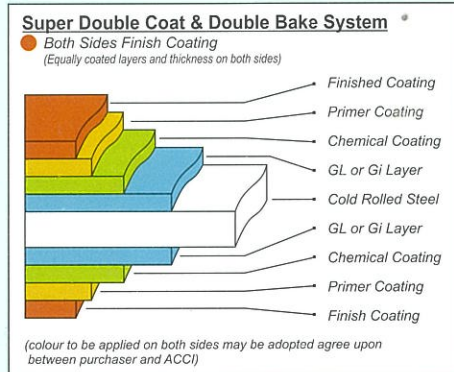
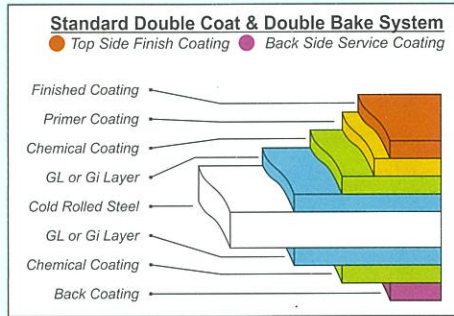

## INSTALLATION

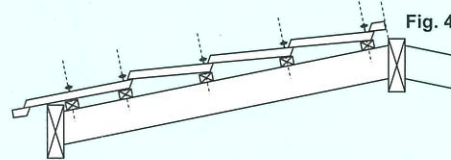
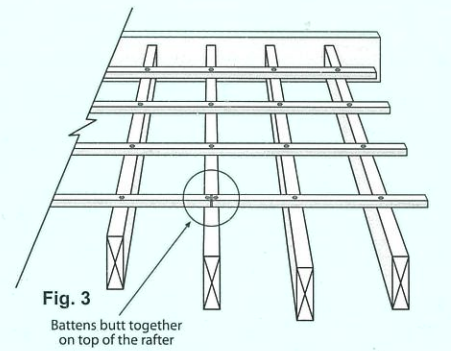
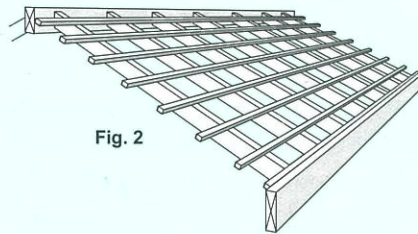
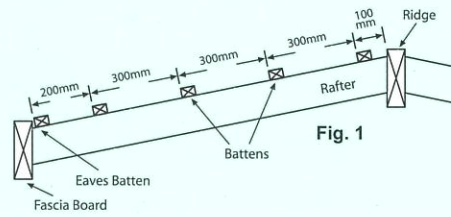

## ROOF LAYING

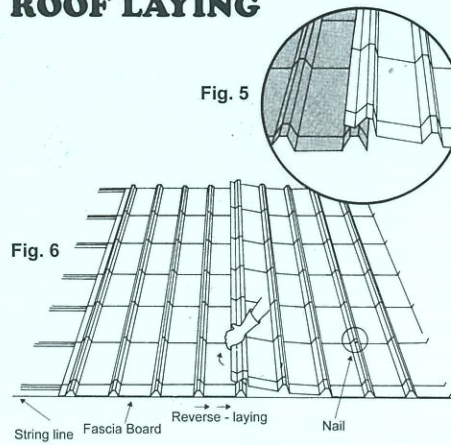

## BATTEN SPACING

Rumako are supported on roof battens on the rafters. Tack the eaves batten against the fascia board. Then set and tack the second batten. (Fig.1). Lay the rest of the battens to module length 300mm across the rafters up the ridge and tack them in position. (Fig.2). Battens are cut to length so they butt together on top the rafters. (Fig.3).

Minimum sizes for timber battens recommended.

Rafter Centres To Centres	Batten Sizes
Up to 600 mm (2'-0")	50 mm x 38 mm (2" x 1.5")
Up to 1200 mm (4'-0")	50 mm x 50 mm (2" x 2")
Up to 1500 mm (5'-0")	50 mm x 65 mm (2" x 2.5")
Up to 1800 mm (6'-0")	50 mm x 75 mm (2" x 3")

Rumako are laid with steps stepping down the slope. (Fig.4). When looking from the gutter end the overlapping side is on the left. They are laid from right to left-laying method to ensure a tight module fit for weather security. (Fig.5 & 6).

Place the first roofing sheet in position and tack ridge the sheet to the batten through the third ridge of the profile at the fascia and the ridge, so that the left side of the roofing sheet can be lifted for reversed-laying. (Fig.5 & 6). Run a string line parallel to the fascia board at the front end of the roofing sheets accordingly and square the roofing sheets to the string line. (Fig.6).

## RUMAKO ACCESSORIES

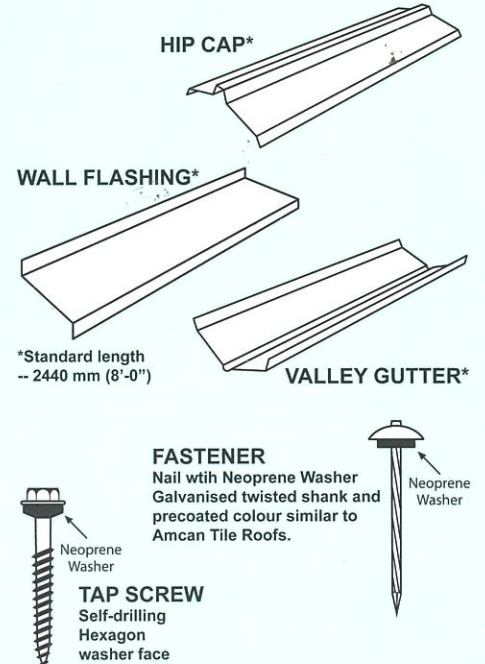

## Amcan Group of Companies

### Kuching Factory/Office:

Lot 779, Block 7, Jalan Demak Laut 3, MTL D, Sejingkat Industrial Park, 93050 Kuching, Sarawak, Malaysia.  
 Tel : 6082-432323 Fax : 6082-432828  
 Email : amcan\_my@streamyx.com  
 Website : www.amcancolor.com

### Johor Bahru Factory/Office:

Lot Plo 270, Jalan Firma 3, Tebrau Industrial Estate IV, 81100 Johor Bahru, Johor, Malaysia.  
 Tel : 607-3552416 Fax : 607-3552426  
 Email : srsjb@streamyx.com

### Singapore Office:

152-H East Coast Road, Singapore 428859  
 Tel : 65-63482486, 65-63459892  
 Fax : 65-63482487  
 Email : amcansg@singnet.com

### Kota Kinabalu Factory/Office:

Lot 2, Jalan Limau Manis, Off Jalan Lintas, Off Mile 5, Jalan Tuaran, 88450 Kota Kinabalu, Sabah, Malaysia.  
 Tel : 6088-424662 Fax : 6088-424661  
 Email : smsbkk@streamyx.com

### Selangor Darul Ehsan Factory/Office:

22, Lot 10327, Batu 5.5, Jalan Bukit Kemuning, Kampung Jawa, 41000 Klang, Selangor Darul Ehsan.  
 Tel: 603-51617541 Fax: 603-51617541

### Kuala Lumpur Office:

4-2-4, Queen's Avenue, Jalan Bayam 55100 Kuala Lumpur  
 Tel : 603-92055330 Fax : 603-92055320  
 Email : steelon@streamyx.com