

Amcan

Architectural products at its best

S25 YODO STANDING SEAM.

YODO ZIP-65.

High-ribbed Standing Seam

Premium 55% Al-Zn Alloy Coated Steel

www.amcancolor.com



Ultimate System of Thermal Insul



Amcan **YODO STANDING SEAM** or S25 features a 25mm profile height of traditional lock-form standing seam; mechanically locked in the field by a mechanical seamer or lock by using hand seamer. It is recommended to be installed over a solid substrate, such as plywood and under-lying roof felt.

- Applicable for buildings that require roof systems that are pitched, curved and even tapered.

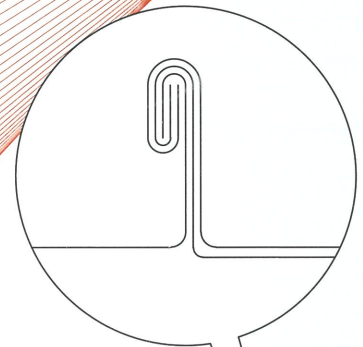

	Total Coated Thickness mm	Seam Height mm	Effective Panel Width		Sprung Curve	Min Roof Pitch Degree
			Min mm	Max mm	Min mm	
Light	0.48	25	230	530	40000	3
Standard	0.66	25	230	530	30000	3

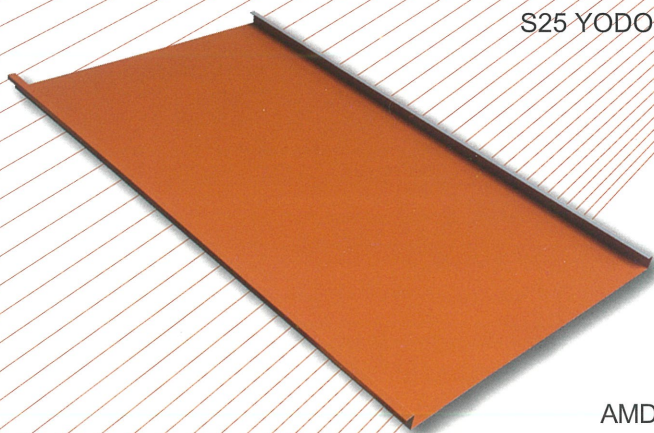

S25 YODO STANDING SEAM

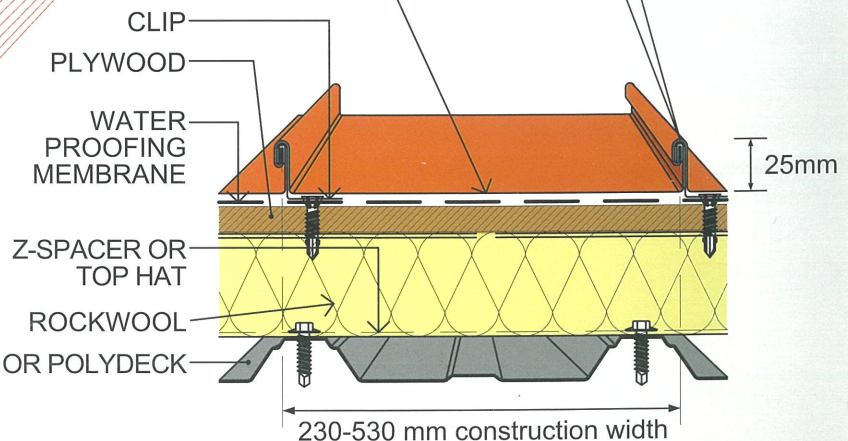

S25 YODO STANDING SEAM.



Solutions for Performance Criteria and Acoustic Sound Reduction

YODO ZIP-65.

High-ribbed Standing Seam

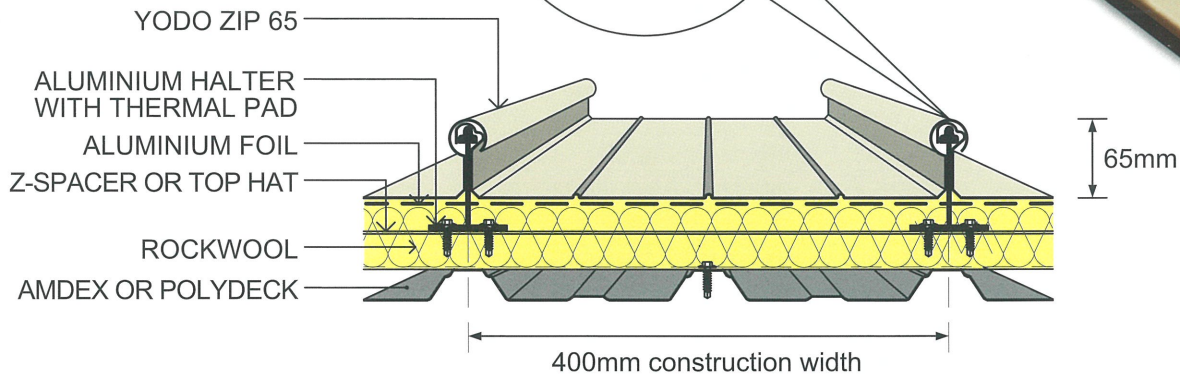

YODO ZIP-65. the concealed high ribbed standing seam roofing system caters for special architectural design and specification. It is designed for modern buildings, fitted with double skinned roof with acoustic requirement.

- Applicable for buildings that require large roofing span like International Airport, large institutions and commercial building projects.



	Total Coated Thickness mm	Max Recommended Spacing of Supports			
		Roofs		Walls	
		Single Span mm	Internal Span mm	Single Span mm	Internal Span mm
Standard	0.66	1800	2050	2050	2500

Tolerances: Length ± 10 mm, Cover Width ± 4 mm, Thickness ± 0.02 mm

AmcanColors Series

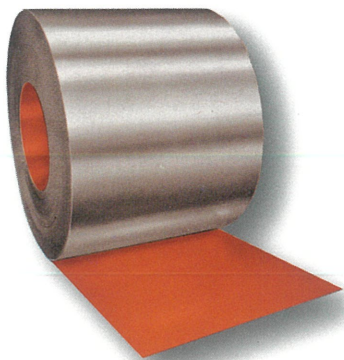

HPE
AmcanColors[®]
- High performance Polyester

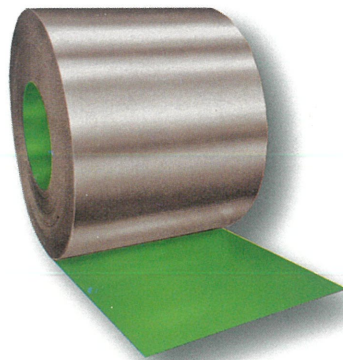

DuraTherm
AmcanColors[®]
- Super durable thermal control

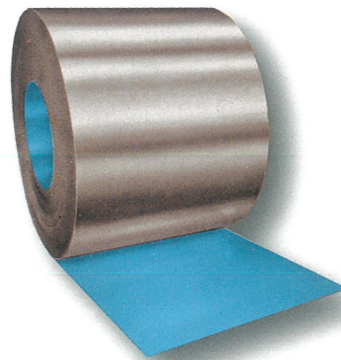

DuraFresh
AmcanColors[®]
- Super durable freshness

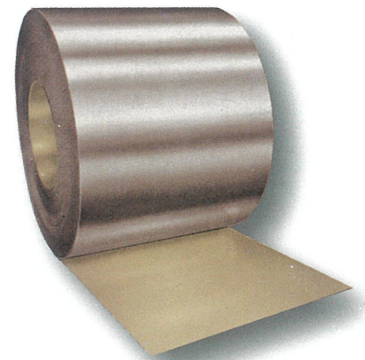

DuraFluor
AmcanColors[®]
- Super durable PVdF

Full Range with Complete Accessories

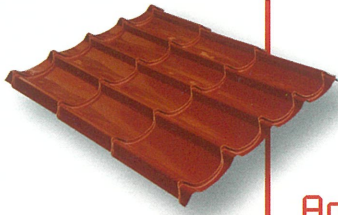

AmcanTile



Clip-deck



Yodo Zip-65

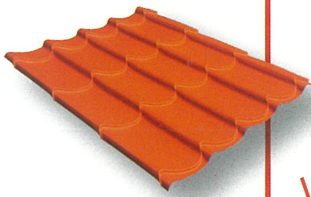

ValenTile

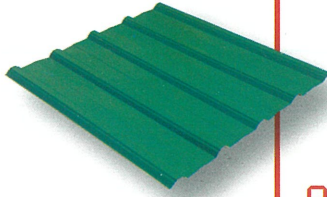

Amdex

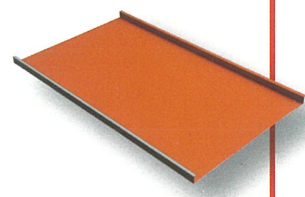

S25 Yodo Standing Seam



Classiko

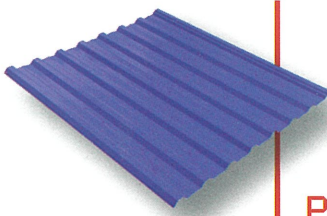

Polydeck

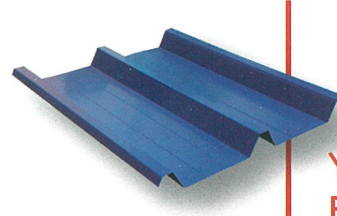

Yodo Roof 66



Rumako

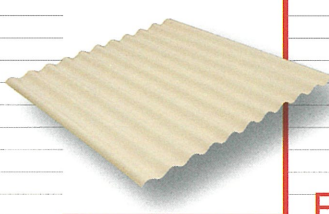

PolyOrb

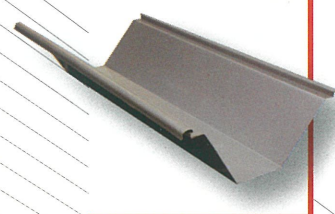

Yodo Roof 166 Seam Type

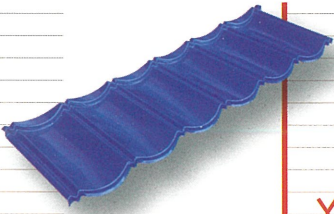

YodoTile

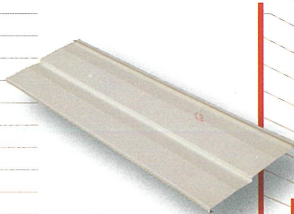

Flexiclad

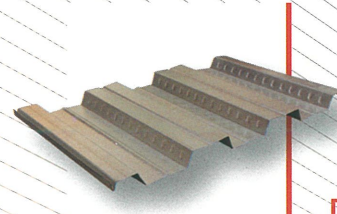

Deck Plate



AMCAN GROUP

Sarawak Factory/Head Office Lot 779, Block 7, Jalan Demak Laut 3, MTLD Sejingkat Industrial Park, 93050 Kuching, Sarawak, Malaysia. Tel: +6082 432 323 Fax: +6082 432 828 Email: amcancolor@gmail.com

Sabah Factory/ Office Lot 2, Jalan Limau Manis, Off Jalan Lintas, Off Mile 5, Jalan Tuaran, 88450 Kota Kinabalu, Sabah, Malaysia. Tel: +6088 428484 Fax: +6088 424661

Johor Bahru Factory/ Office Lot Plo 270, Jalan Firma 3, Tebrau Industrial Estate IV, 81100 Johor Bahru, Johor, Malaysia. Tel: +607 3552416 Fax: +607 3552426

Kuala Lumpur Office 4-2-4, Jalan Bayan, Queen's Avenue, 55100 Kuala Lumpur, Malaysia. Tel: +603 92055330 Fax: +603 92055320

Singapore Office 152-H, East Coast Road, Singapore. Tel: +65 63482486 Fax: +65 63482487

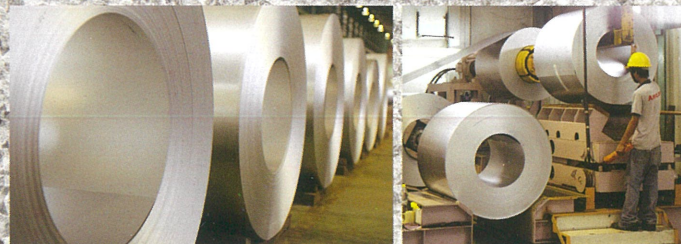

Premium 55% Al-Zn Alloy Coated Steel in Amcan Color Coating Process